

Item No.: **LB417-L22**

Applications

For over 20ft. (6 meter) applications factories, foundries, machines shops, warehouse, and large retail stores.

Specification Features

- UL and CUL listed for damp locations
- Superior heavy duty die cast aluminum construction with white powder coating finish
- Mogul base socket-E39 standard, UL approved
- Comes with a hook for easy mounting
- Anodized aluminum which has been spun and anodized
- Reflector comes in 16 inches or 22 inches or 28 inches
- Ideal for HPS and MH 400 Watts Max



Engineering Dimensions

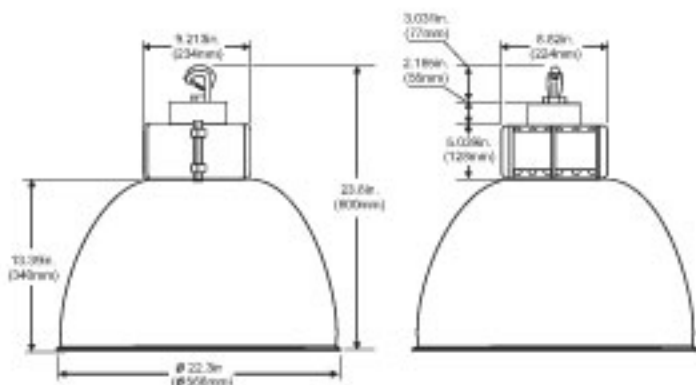

Line Drawing



Packing Information

	Weights	Cubit Feet	Master Carton Qty	40' Container Qty
LB-417EB	6.39LBS	0.569'	1 PC	3600 PCS
22" Reflector(AI)	20.19LBS	5.829'	6PCS	2100 PCS

