

Item No.: **LB416-L16A**



### Applications

For over 20 ft. (6 meter) applications factories, foundries, machines shops, warehouse, and large retail stores.

### Specification Features

- UL and CUL listed for damp locations
- Superior heavy duty die cast aluminum construction with white powder coating finish
- Mogul base socket-E39 standard, UL approved
- Comes with a hook for easy mounting
- Anodized aluminum which has been spun and anodized
- Reflector comes in 16 inches or 22 inches
- Ideal for HPS and MH 250 Watts Max

### Engineering Dimensions

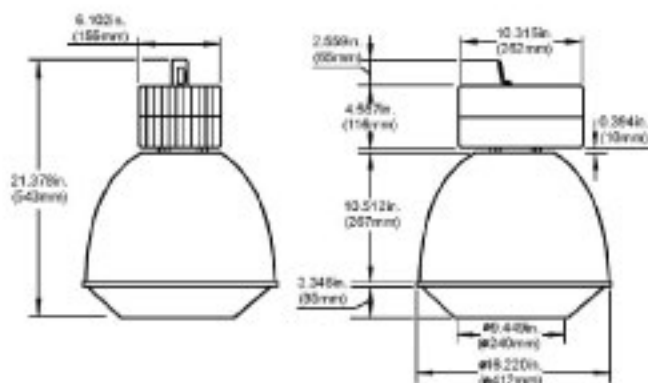

### Line Drawing



### Packing Information

	Weights	Cubit Feet	Master Carton Qty	40' Container Qty
LB-416EB	4.63LBS	0.342'	1 PC	5900 PCS
16" Reflector(Al)	22.88LBS	3.295'	12PCS	7400 PCS
16" Clamp Band(Al)	3.62LBS	0.897'	12PCS	27000 PCS
16" Drop Lens(Acrylic)	15.74LBS	1.655'	12PCS	14000 PCS