

Item No.: **IL417-L16**



Applications

For over 20ft. (6 meter) applications factories, foundries, machines shops, warehouse, and large retail stores.

Specification Features

- UL and CUL listed for damp locations
- Superior heavy duty die cast aluminum construction with white powder coating finish
- Mogul base socket-E39 standard, UL approved
- Comes with a hook for easy mounting
- Anodized aluminum which has been spun and anodized
- Reflector comes in 16 inches or 22 inches
- Ideal for HPS and MH 400 Watts Max

Engineering Dimensions

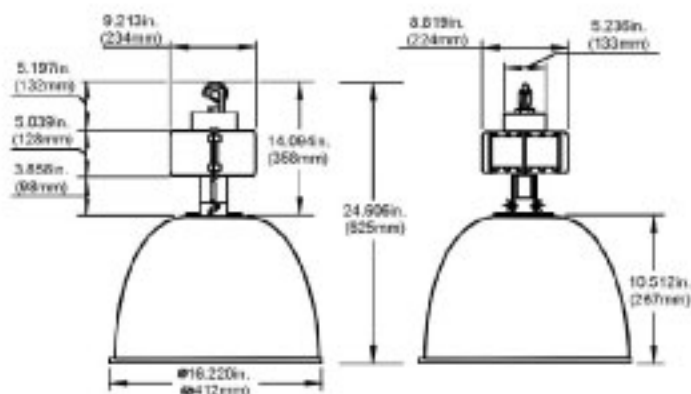

Line Drawing

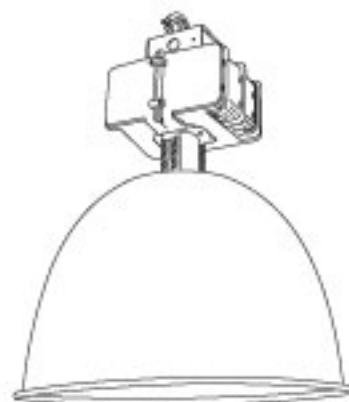

Packing Information

	Weights	Cubit Feet	Master Carton Qty	40'Container Qty
HB-417EB	6.79LBS	0.569'	1 PC	3600 PCS
16" Reflector(AI)	22.88LBS	3.295'	12PCS	7400 PCS

